

ONKYO® SERVICE MANUAL

AUDIO VIDEO CONTROL RECEIVER MODEL TX-SV373

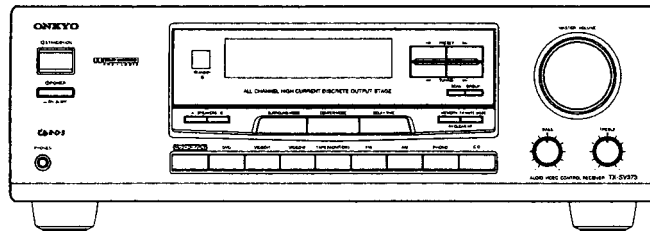

Black model

BMDN	120V AC, 60Hz
BMP,BMPT	230V AC, 50Hz
BMWT,BMWR	220-230V/120V AC, 50/60Hz

Black and Golden models

BMWT,BMWR,GMWT,GMWR	220-230V/120V AC, 50/60Hz
---------------------	---------------------------

SAFETY-RELATED COMPONENT WARNING!!

COMPONENTS IDENTIFIED BY MARK \triangle ON THE SCHEMATIC DIAGRAM AND IN THE PARTS LIST ARE CRITICAL FOR RISK OF FIRE AND ELECTRIC SHOCK. REPLACE THESE COMPONENTS WITH ONKYO PARTS WHOSE PART NUMBERS APPEAR AS SHOWN IN THIS MANUAL.

MAKE LEAKAGE-CURRENT OR RESISTANCE MEASUREMENTS TO DETERMINE THAT EXPOSED PARTS ARE ACCEPTABLY INSULATED FROM THE SUPPLY CIRCUIT BEFORE RETURNING THE APPLIANCE TO THE CUSTOMER.

TABLE OF CONTENTS

Specifications.....	2
Service procedures.....	3
Panel views.....	4
PC board-parts list	6
Microprocessor connection diagram	10
Microprocessor terminal description	11
Block diagram Tuner section.....	12
IC block diagrams and descriptions.....	13
Adjustment procedures.....	16
Exploded view	19
Wiring view	21
Block diagram.....	23
Schematic diagram.....	25
Packing view.....	46
Panel views.....	1
Exploded view	2
PC board-parts list	5
Schematic diagram.....	6
Packing view.....	7



MICROPROCESSOR-CONNECTION DIAGRAM

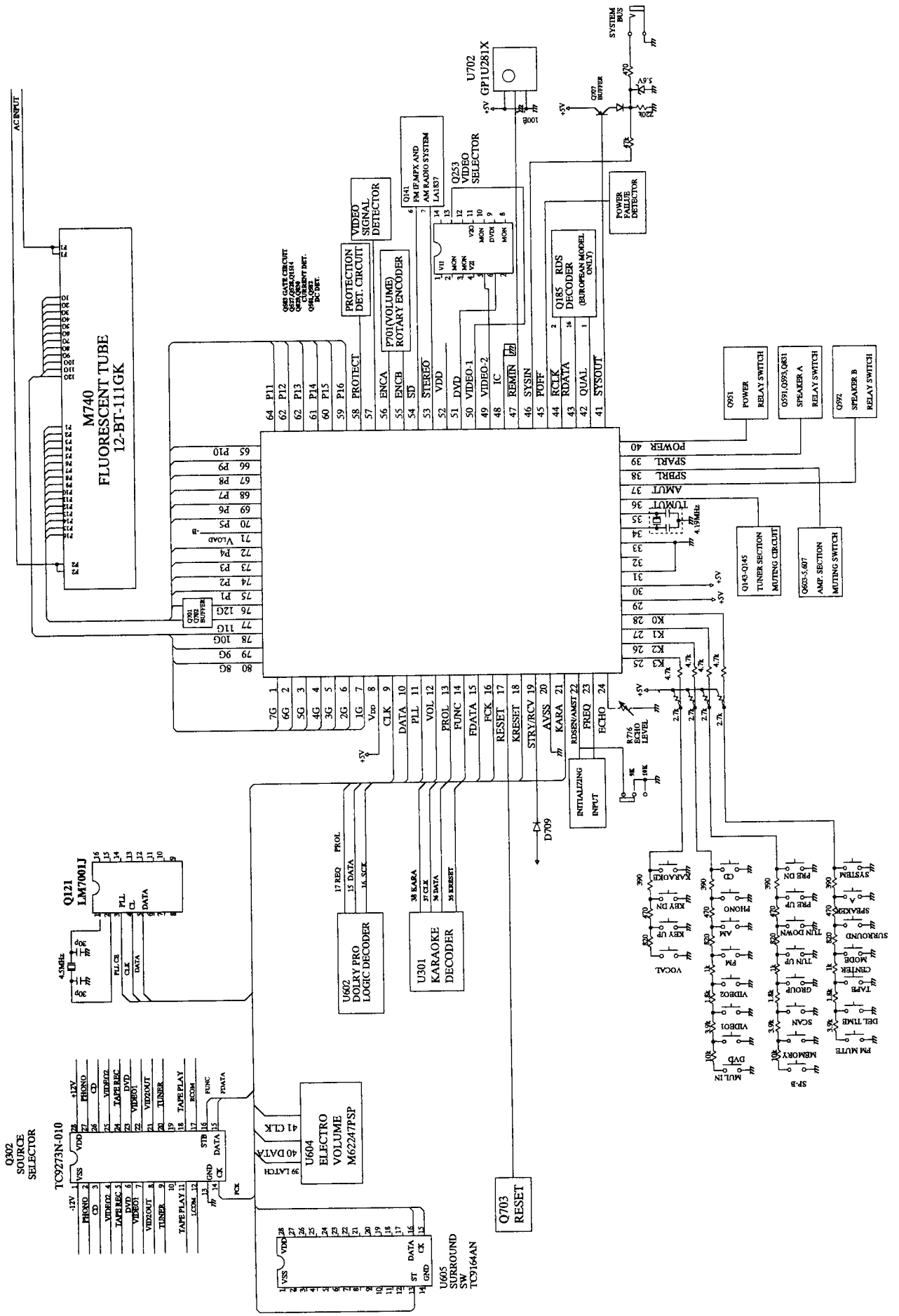

BLOCK DIAGRAM TUNER SECTION

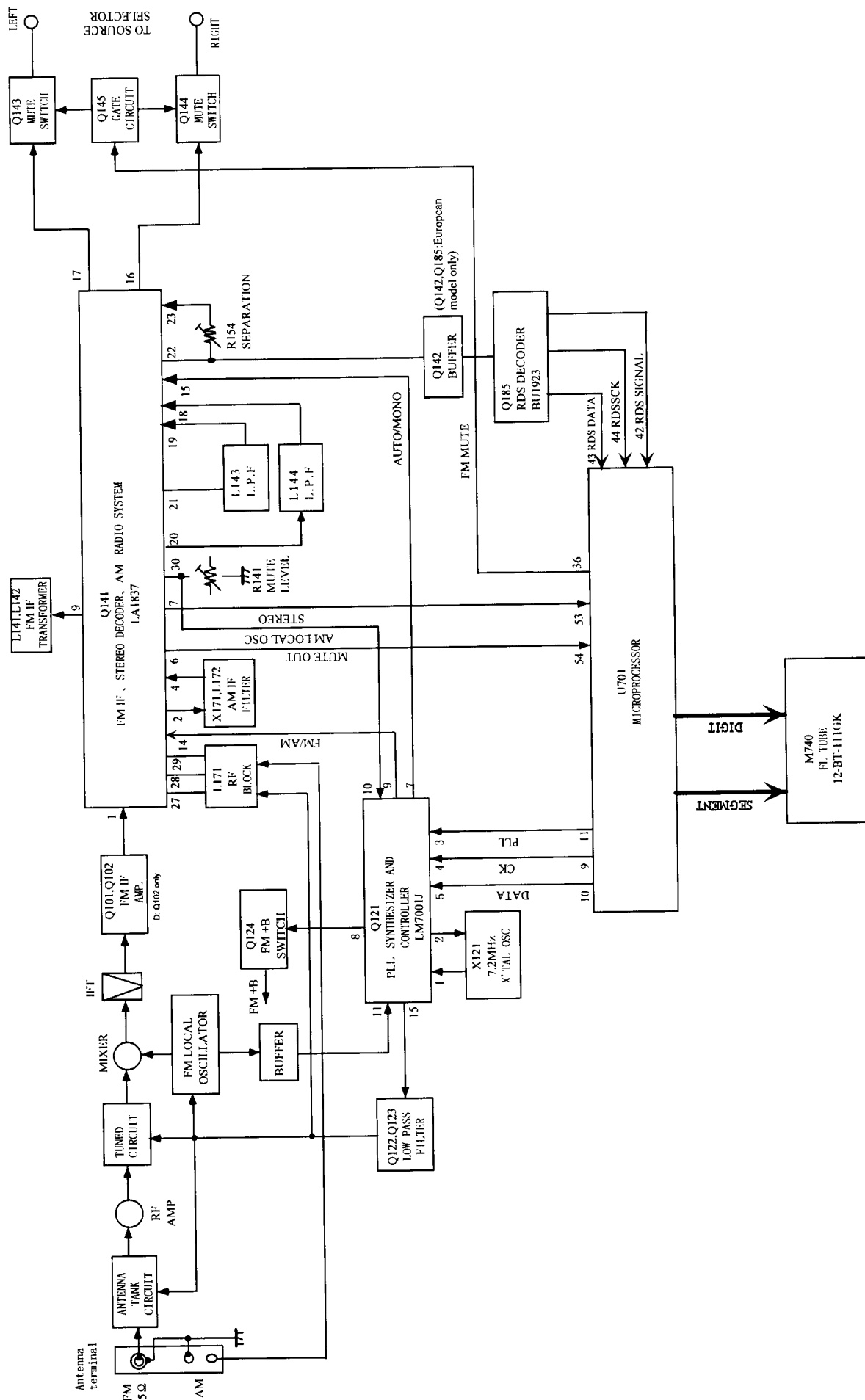

Preparation

1. Input

FM mono: 1kHz, 75kHz devi., 60dB/μV

FM stereo: 1kHz, 67.5kHz devi., 60dB/μV

Pilot signal 19kHz, 7.5kHz devi.

AM: 400Hz, 30% mod.

2. Outputs

Connect the non-inductive type resistor of 8 ohms to the all speaker terminals unless otherwise noted.

FM Adjustment

Item	Step	Connection of instrument	FM SG output	Stereo modulator output	Tuning frequency	Output indicator	Adjustment point	Adjust for	Remarks
FM IF/RF	1					DC voltmeter	L141	0±20mV	FM MUTE/STEREO switch-ON/STEREO Repeat the steps 1 and 3 until no further adjustment is necessary.
	2	Fig 1	99.0MHz 1kHz 75kHz devi. 65dB(60dB)	—	99.0MHz	AC voltmeter	IFT on the front end	Maximum	
	3					Distortion analyzer	L142	Minimum	
Stereo Distortion		Fig 2	99.0MHz Ext. mod. 65dB(60dB)	Channel L or R 1kHz	99.0MHz	Distortion analyzer	IFT on the front end	Minimum	Don't turn more than ±180°
	1	Fig.2	99.0MHz Ext. mod. 65dB(60dB)	Channel L 1kHz Channel R 1kHz	99.0MHz	Channel R AC voltmeter Channel L AC voltmeter	R156	Minimum Minimum	Maximum and same separation
Muting Level	3	Fig.3	99.0MHz 19.2dB(14dB)	—	99.0MHz	Oscilloscope or TUNED indicator	R141	Signal output or light on	

AM adjustment

120V model

Step	AM SG output	Tuning Frequency	Output Indicator	Adjustment point	Adjust for
1		530kHz	Digital DC voltmeter	OSC coil on RF block L171	1.4±0.2V
2	600kHz 400Hz 30% mod. 60dB/m	600kHz	AC voltmeter	RF coil on RF block L171	Maximum
3	990kHz 400Hz 30% mod. 60dB/m	990kHz	AC voltmeter	L172	Maximum

230V and worldwide models

Step	AM SG output	Tuning Frequency	Output Indicator	Adjustment point	Adjust for
1		522kHz or 531kHz	Digital DC voltmeter	OSC coil on RF block L171	1.4±0.2V
2	603kHz 400Hz 30% mod. 60dB/m	603kHz	AC voltmeter	RF coil on RF block L171	Maximum
3	998kHz 400Hz 30% mod. 60dB/m	998kHz	AC voltmeter	L172	Maximum

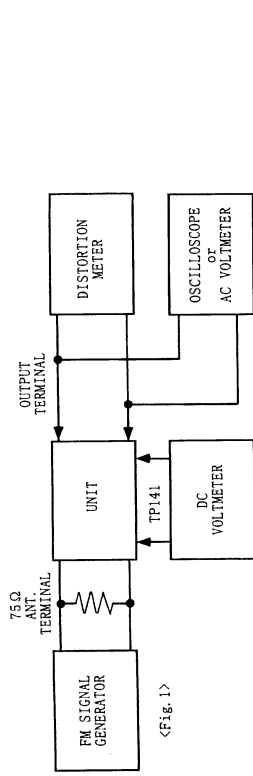

<Fig. 1>

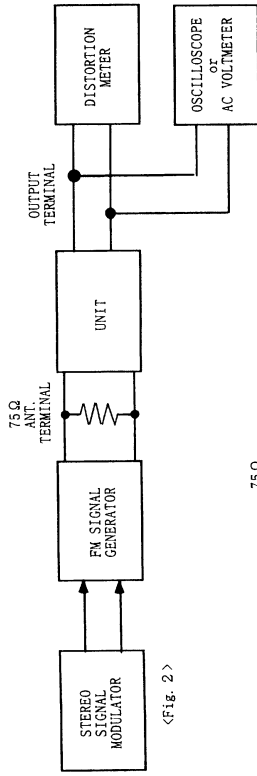

<Fig. 2>

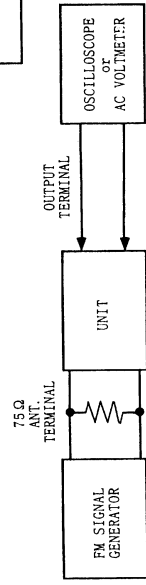

<Fig. 3>

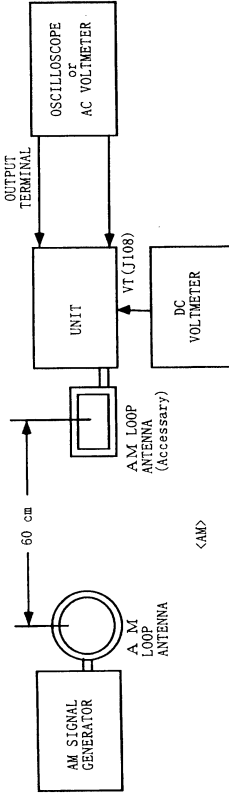

<AM>

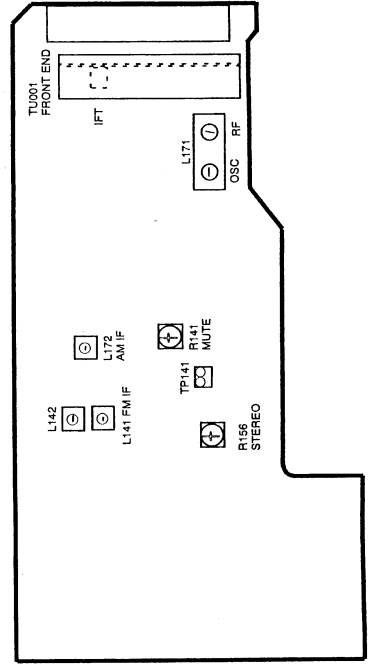

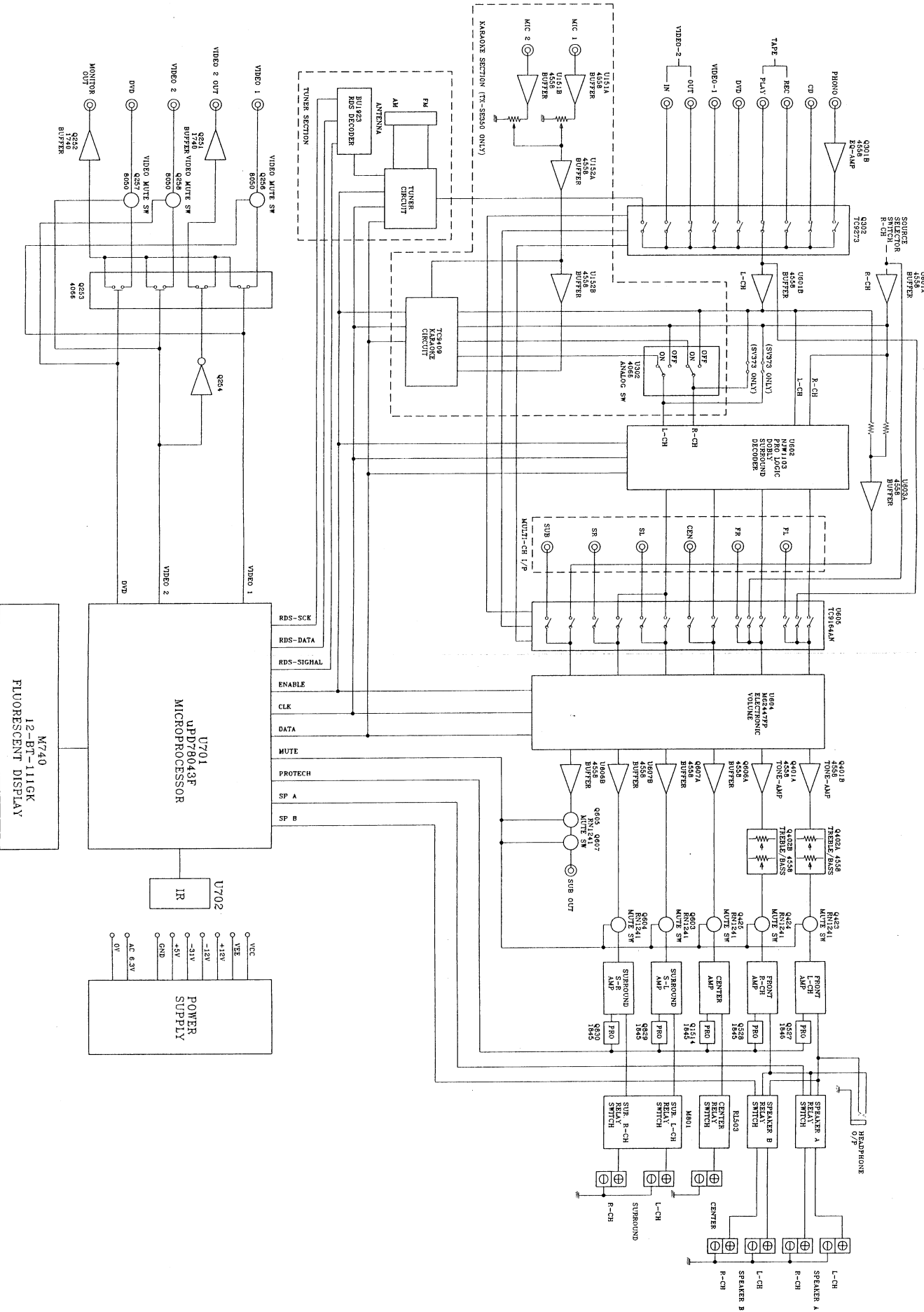

A B C D E F G

SCHEMATIC DIAGRAM

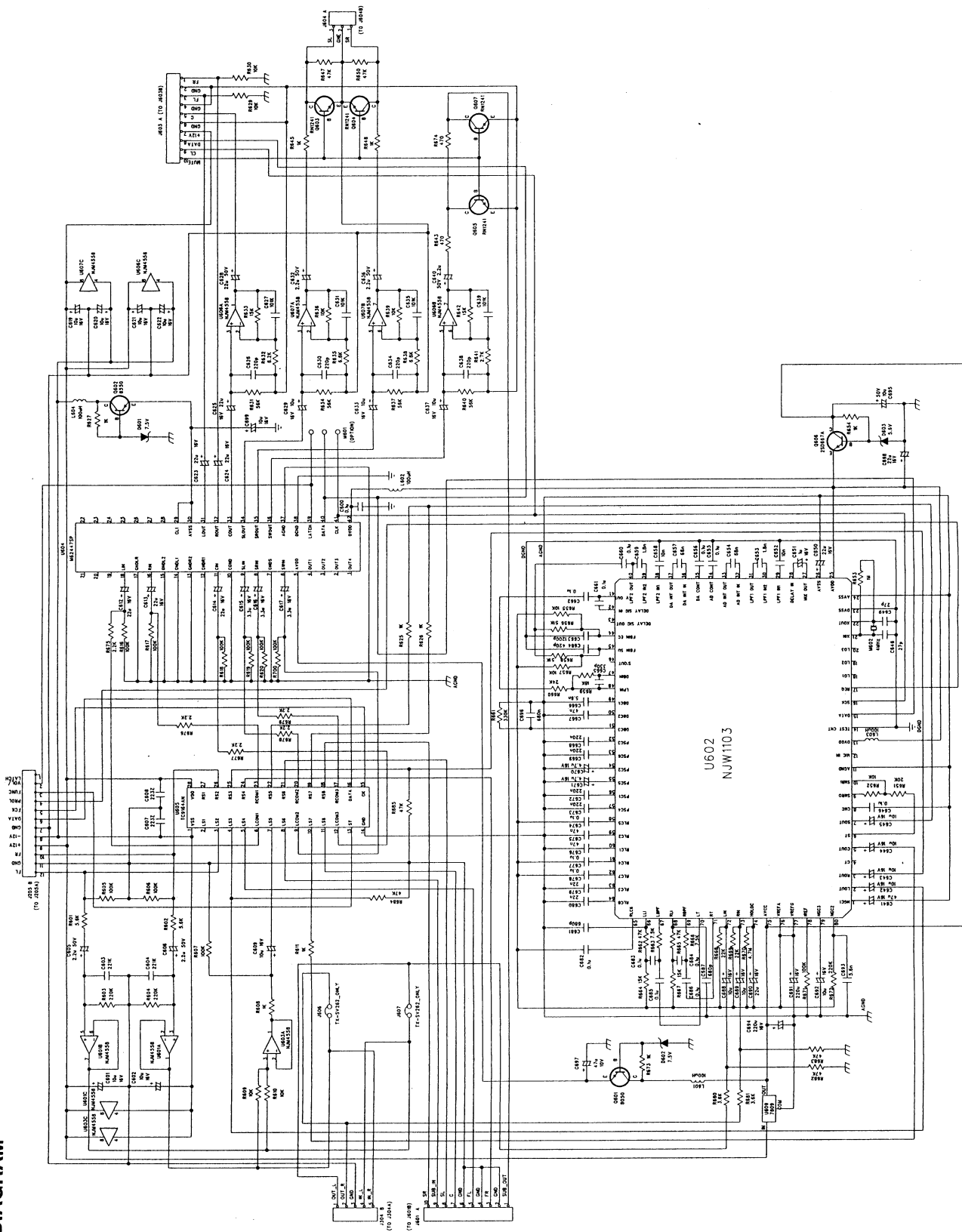

A B C D E F G

SCHEMATIC DIAGRAM

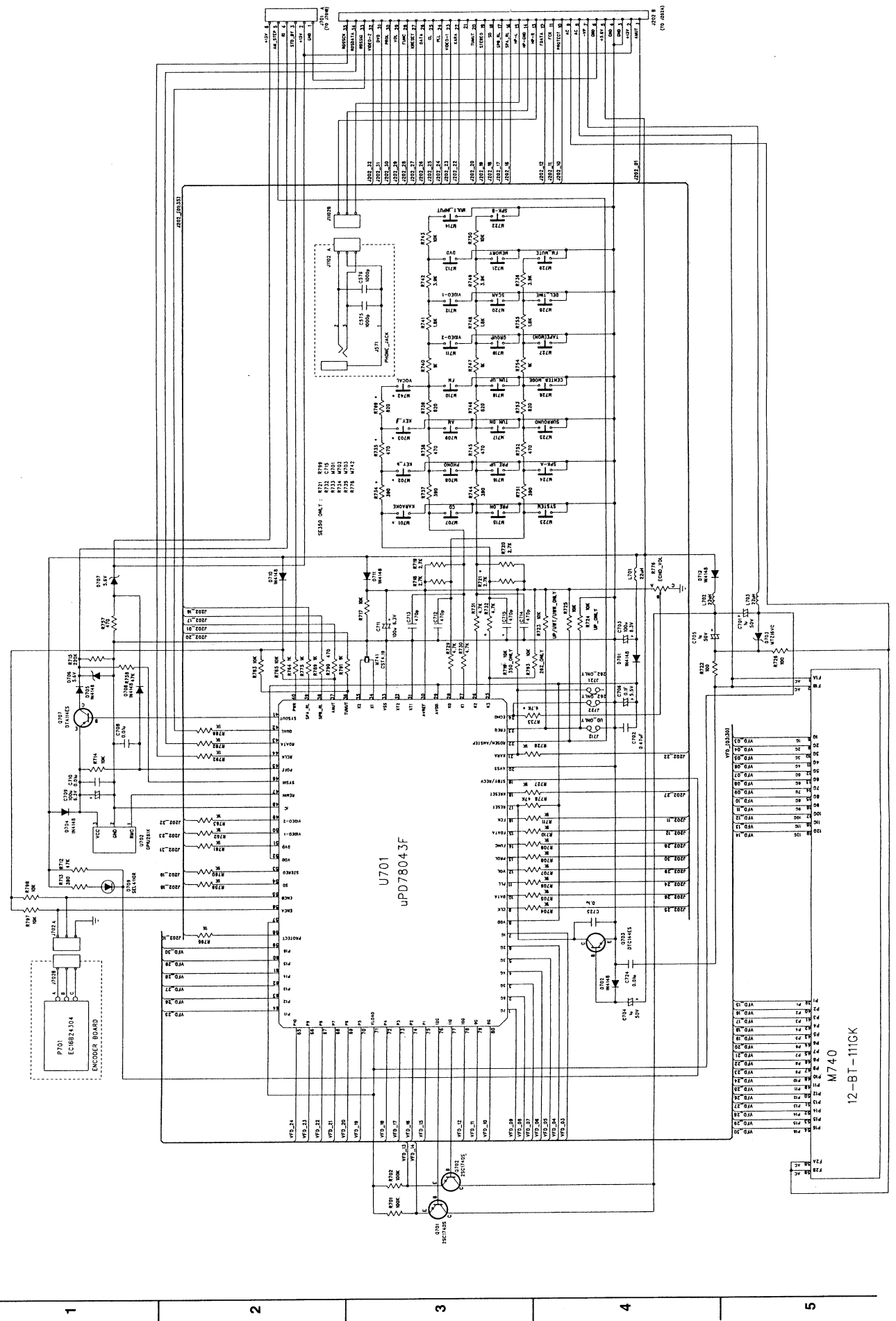

A B C D E F G

SCHEMATIC DIAGRAM

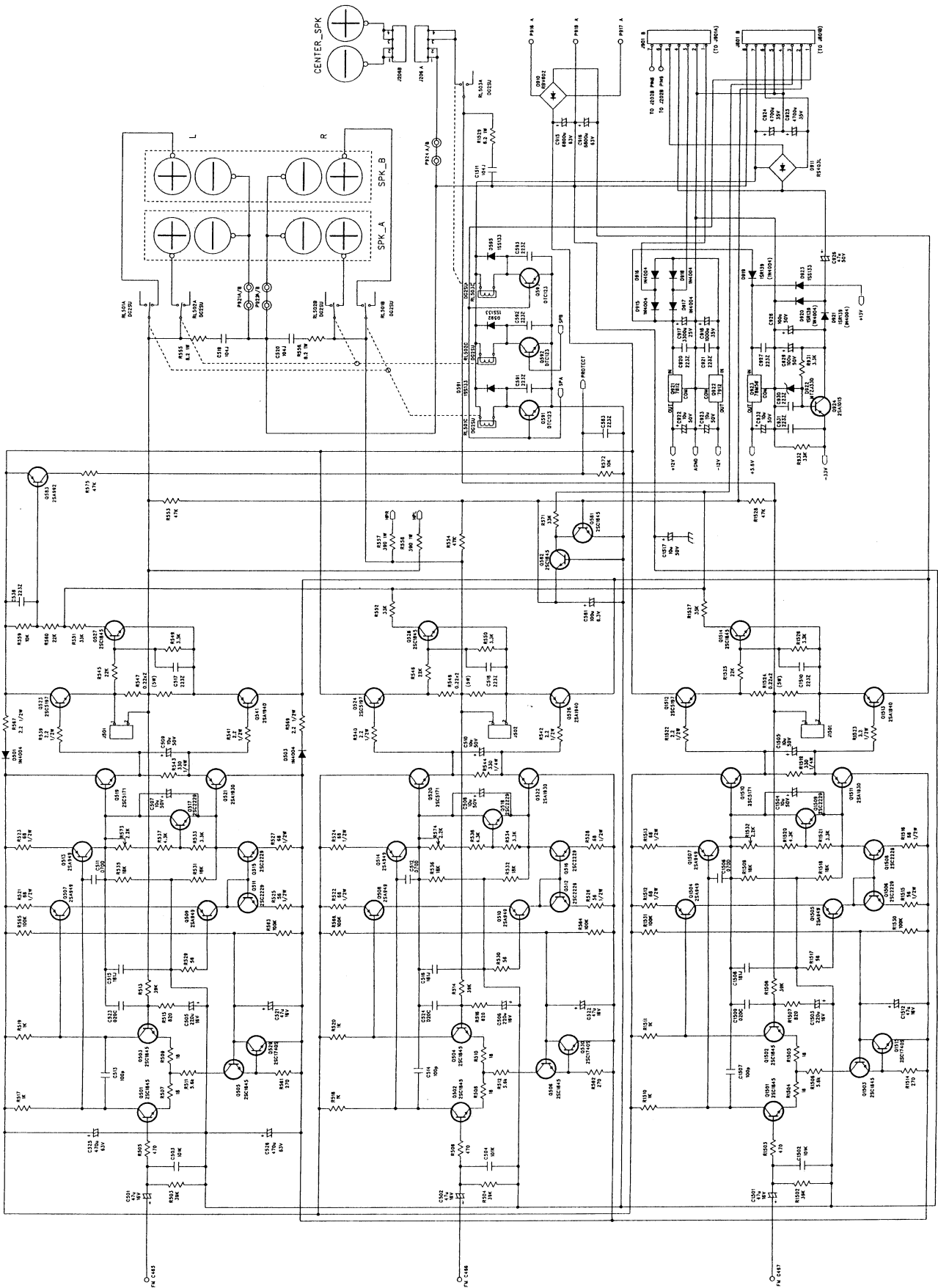

1

2

3

4

5

SCHEMATIC DIAGRAM

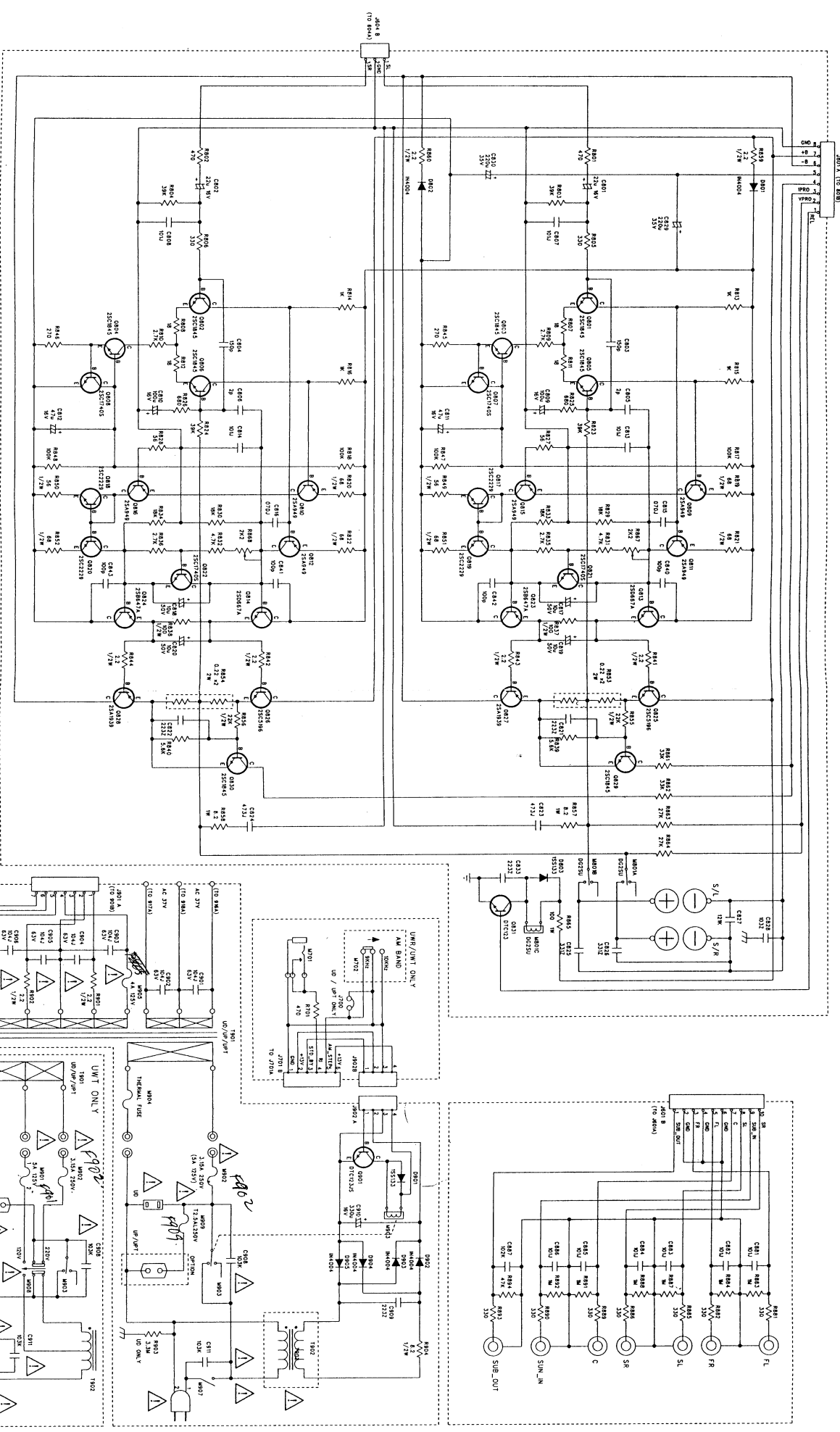

NOTE : COMPONENTS MARKED WITH "  " ARE SAFETY CRITICAL PARTS.

A B C D E F G

12/08/2000

Model: TX-SV373

Correction: Error in Print and adjustment Procedure on page 16 .

Before Correction

ADJUSTMENT PROCEDURES

Fig1

Idling current adjustment

Before Idling adjustment, turn the trimming resistors R573, R574, R867, R868 and R1532 to counter clockwise.

Connect the DC voltmeter to sockets J501, J502, TP801, TP802 and J1501.

After turn POWER to ON, adjust the trimming resistors R573, R574, R867, R868 and R1532 so that the reading of voltmeter becomes $0.5 \pm 0.2\text{mV}$.

After adjustment, attach the top cover.

Confirm the voltage of above points after five minutes.

Readjust the above resistors so that the voltage becomes $0.5 \pm 0.2\text{mV}$.

Note: No load and No signal

After Correction

ADJUSTMENT PROCEDURES

Fig2

Idling current adjustment

Before Idling adjustment, turn the trimming resistors R573, R574, R867, R868 and R1532 to counter clockwise.

Connect the DC voltmeter to sockets J501, J502, TP801, TP802 and J1501.

After turn POWER to ON, adjust the trimming resistors R573, R574, R867, R868 and R1532 so that the reading of voltmeter becomes $5\text{mV} \pm 2\text{mV}$

After adjustment, attach the top cover.

Confirm the voltage of above points after five minutes.

Readjust the above resistors so that the voltage becomes $5\text{mV} \pm 2\text{mV}$

Note: No load and No signal